

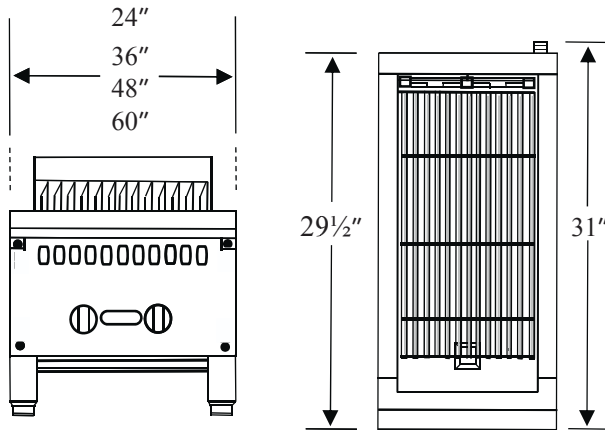

BROILERS

Radiant Style CCHRB Series
24", 36", 48" & 60" widths



Model CCHRB60

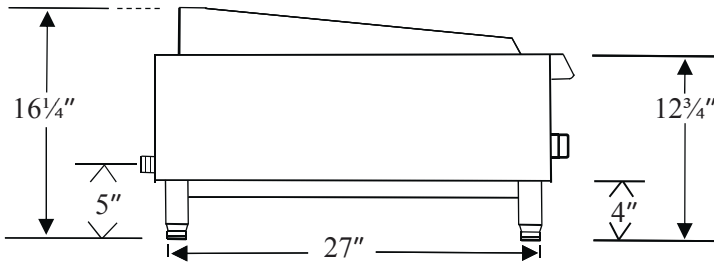

Standard Features, Benefits & Options

CONSTRUCTION: 24", 36", 48" & 60" wide models available. Easy cleaning, corrosion resistant stainless steel finish. Double wall construction, insulated for energy efficiency. 3 1/4" bull-nose landing. 4" tall adjustable legs. 3 1/2" grease trough. Stainless steel drip tray.

CONTROLS: 3/4" rear gas connection, brass gas valves, front accessible automatic standing pilots, pressure regulators and cool to the touch control knobs.

BURNERS: Straight cast iron burners each rated at 20,000 BTU's, 1 burner per 6" increment. Under burner deflector separating pan grease from burner flame.

BROILER: Heavy 5.5" wide cast iron tilt-able top grates. Top grates lay flat or at an angle. Cast iron radiants cover the burners.

TESTING: Optimal pressure is 4" WC for natural gas, 10" WC for propane. ETL design & ETL Sanitation (ANSI-NSF4) certified.

Model #	Packing inches ----- millimeters	Burners ----- Total BTU	Net Wgt. lbs. / kg.	Gross Wgt. lbs. / kg.
CCHRB24	35 x 35 x 21 89 x 89 x 53	4 80,000	187 / 85	247 / 112
CCHRB36	42 x 35 x 21 107 x 89 x 53	6 120,000	287 / 130	348 / 158
CCHRB48	53 x 35 x 21 134 x 89 x 53	8 160,000	368 / 167	434 / 197
CCHRB60	65 x 35 x 21 164 x 89 x 53	10 200,000	463 / 210	545 / 247

